

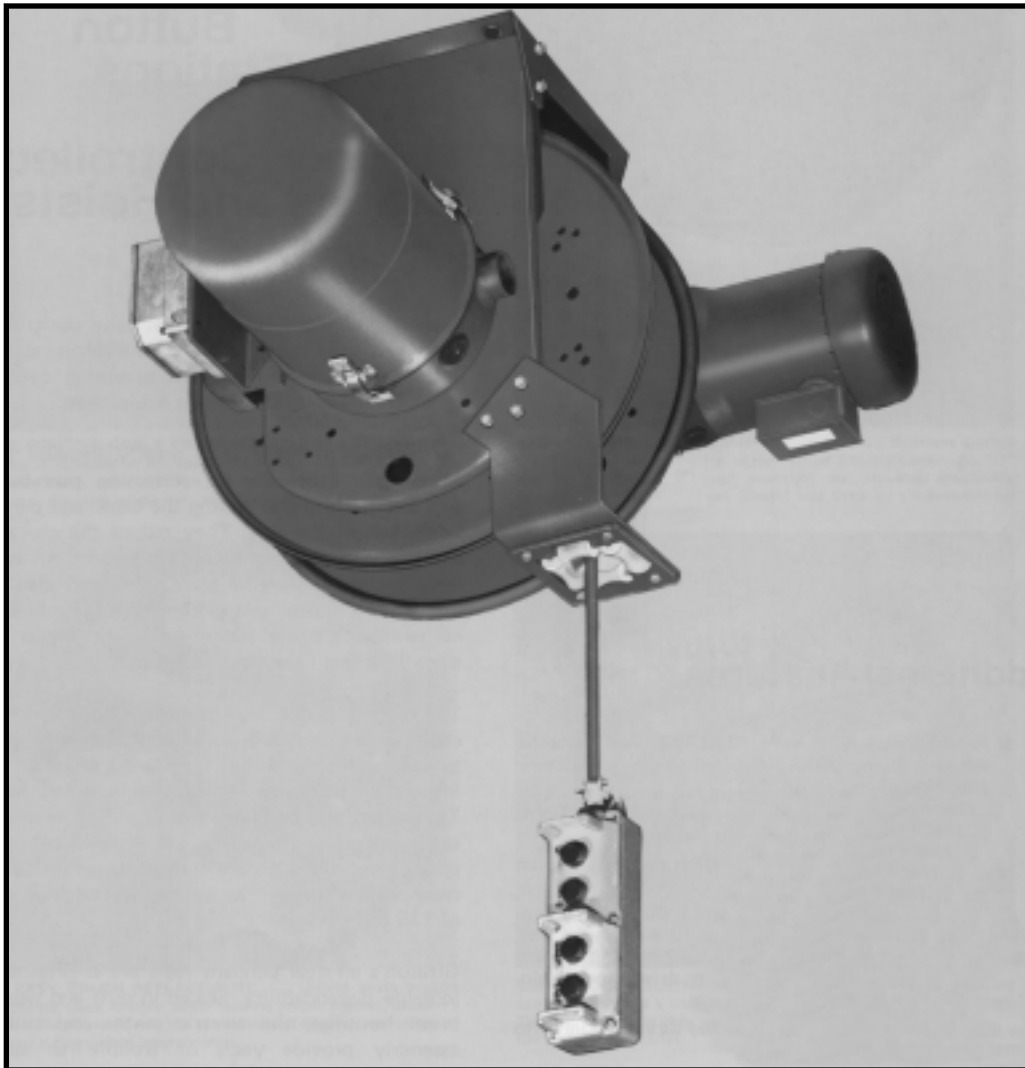

# MOTOR DRIVEN PENDANT STATION REELS



## Automatically Raise and Lower Push-Button Stations for Floor Controlled Cranes and Hoists

- Wind and store up to 120 feet of cable.
- Average retrieval speed - 135 fpm (40.5mpm).
- Reversible 1,800 RPM, 230-460 VAC drive motor.  
(Consult factory for DC, hazardous duty or explosion proof motor.)
- Electro-magnetic brake holds cable in place when motor is de-energized.
- NEMA IV two-way limit switch controls up and down stops.
- Cataloged capacities from 2–36 conductor cables, No.16 through No.10 AWG wire size.  
(No. 8 – 1/0 AWG also available. Consult factory.)
- Four-way roller guide.
- Weatherproof, dust-tight NEMA 4 (IP-54) slip-ring housing.
- Welded steel frame
- Pre-lubricated, self-aligning bearings.
- Durable baked polyester finish.



# PENDANT STATION SELECTION CHART...Computer

WIRE SIZE	No. Cond.	Max Pndnt. Wt lbs (kg)	CABLE LENGTH-FEET						
			20	30	40	50	60	70	
No. 16	2	4 (1.8)	P14-23-8-25	P14-23-8-25	P14-23-8-25	P14-23-8-25	P14-23-8-25	P14-23-8-25	P14-23-8-25
	3	6 (2.7)	P14-33-8-25	P14-33-8-25	P14-33-8-25	P14-33-8-25	P14-33-8-25	P14-33-8-25	P14-33-8-25
	4	8 (3.6)	P14-43-8-25	P14-43-8-25	P14-43-8-25	P14-43-8-25	P14-43-8-25	P14-43-8-25	P14-43-8-25
	6	12 (5.4)	P14-63-8-25	P14-63-8-25	P14-63-8-25	P14-63-8-25	P14-63-8-25	P14-63-8-25	P16-63-8-25
	8	16 (7.2)	P14-83-8-25	P14-83-8-25	P16-83-8-25	P16-83-8-25	P16-83-8-25	P16-83-8-25	P18-83-8-25
	10	20 (9.0)	P16-103-8-25	P16-103-8-25	P18-103-8-25	P18-103-8-25	P18-103-8-25	P21-103-8-25	P21-103-8-25
	12	24 (10.8)	P16-123-8-25	P16-123-8-25	P18-123-8-25	P18-123-8-25	P21-123-8-25	P21-123-8-25	P21-123-8-25
	14	28 (12.6)	P16-143-9-25	P18-143-9-25	P21-143-9-25	P21-143-9-25	P21-143-9-50	P21-143-9-50	P21-143-9-50
	16	32 (14.4)	P16-163-8-25	P16-163-8-25	P18-163-8-25	P18-163-8-25	P21-163-8-50	P21-163-8-50	P21-163-8-50
	20	40 (18.0)	P16-203-8-25	P16-203-8-25	P18-203-8-50	P18-203-8-50	P18-203-8-50	P21-203-8-50	P21-203-8-50
	24	48 (21.6)	P16-243-9-50	P18-243-9-50	P21-243-9-50	P21-243-9-50	P24-243-9-50	P24-243-9-50	P24-243-9-50
30	60 (27.0)	P18-303-11-50	P21-303-11-75	P21-303-11-75	P24-303-11-75	P24-303-11-75	P24-303-11-75	P28-303-11-75	
36	72 (32.4)	P18-363-11-75	P21-363-11-75	P21-363-11-75	P24-363-11-75	P24-363-11-75	P24-363-11-75	P28-363-11-150	
No. 14	2	4 (1.8)	P14-23-8-25	P14-23-8-25	P14-23-8-25	P14-23-8-25	P14-23-8-25	P14-23-8-25	P14-23-8-25
	3	6 (2.7)	P14-33-8-25	P14-33-8-25	P14-33-8-25	P14-33-8-25	P14-33-8-25	P14-33-8-25	P14-33-8-25
	4	8 (3.6)	P14-43-8-25	P14-43-8-25	P14-43-8-25	P14-43-8-25	P14-43-8-25	P14-43-8-25	P14-43-8-25
	6	12 (5.4)	P14-63-8-25	P14-63-8-25	P16-63-8-25	P16-63-8-25	P16-63-8-25	P16-63-8-25	P18-63-8-25
	8	16 (7.2)	P16-83-8-25	P16-83-8-25	P18-83-8-25	P18-83-8-25	P21-83-8-25	P21-83-8-25	P21-83-8-25
	10	20 (9.0)	P16-103-9-25	P18-103-9-25	P21-103-9-25	P21-103-9-25	P24-103-9-50	P24-103-9-50	P24-103-9-50
	12	24 (10.8)	P18-123-10-25	P21-123-10-25	P24-123-10-50	P24-123-10-50	P24-123-10-50	P24-123-10-50	P24-123-10-50
	14	28 (12.6)	P21-143-11-50	P21-143-11-50	P24-143-11-50	P28-143-11-50	P28-143-11-50	P28-143-11-50	P28-143-11-75
	16	32 (14.4)	P16-163-10-50	P21-163-10-50	P21-163-10-50	P24-163-10-50	P24-163-10-50	P24-163-10-50	P24-163-10-50
	20	40 (18.0)	P18-203-11-50	P21-203-11-50	P21-203-11-50	P24-203-11-75	P24-203-11-75	P24-203-11-75	P28-203-11-75
	24	48 (21.6)	P24-243-12-50	P24-243-12-75	P28-243-12-75	P28-243-12-75	P28-243-12-75	P28-243-12-75	P28-243-12-150
30	60 (27.0)	P24-303-13-75	P28-303-13-75	P28-303-13-150	P28-303-13-150	P28-303-13-150	P28-303-13-150	P28-303-13-150	
No. 12	2	4 (1.8)	P14-23-8-25	P14-23-8-25	P14-23-8-25	P14-23-8-25	P14-23-8-25	P14-23-8-25	P16-23-8-25
	3	6 (2.7)	P14-33-8-25	P14-33-8-25	P14-33-8-25	P14-33-8-25	P14-33-8-25	P14-33-8-25	P16-33-8-25
	4	8 (3.6)	P14-43-8-25	P14-43-8-25	P14-43-8-25	P14-43-8-25	P14-43-8-25	P14-43-8-25	P16-43-8-25
	6	12 (5.4)	P16-63-8-25	P16-63-8-25	P18-63-8-25	P18-63-8-25	P21-63-8-25	P21-63-8-25	P21-63-8-25
	8	16 (7.2)	P16-83-8-25	P16-83-8-25	P18-83-8-25	P18-83-8-25	P18-83-8-25	P21-83-8-25	P21-83-8-25
	10	20 (9.0)	P18-103-10-25	P21-103-10-25	P21-103-10-50	P21-103-10-50	P24-103-10-50	P24-103-10-50	P24-103-10-50
	12	24 (10.8)	P21-123-11-50	P21-123-11-50	P24-123-11-50	P28-123-11-50	P28-123-11-50	P28-123-11-50	P28-123-11-50
	14	28 (12.6)	P24-143-12-50	P24-143-12-50	P28-143-12-50	P28-143-12-75	P28-143-12-75	P28-143-12-75	P28-143-12-75
	16	32 (14.4)	P18-163-10-50	P21-163-10-50	P21-163-10-50	P24-163-10-50	P28-163-10-50	P28-163-10-50	P28-163-10-75
	20	40 (18.0)	P24-203-12-50	P24-203-12-75	P28-203-12-75	P28-203-12-75	P28-203-12-75	P28-203-12-75	P28-203-12-150
	24	48 (21.6)	P24-243-13-75	P28-243-13-75	P28-243-13-75	P28-243-13-150	P28-243-13-150	P28-243-13-150	P28-243-13-150
No. 10	2	4 (1.8)	P14-23-8-25	P14-23-8-25	P14-23-8-25	P16-23-8-25	P16-23-8-25	P16-23-8-25	P16-23-8-25
	3	6 (2.7)	P14-33-8-25	P14-33-8-25	P16-33-8-25	P16-33-8-25	P16-33-8-25	P16-33-8-25	P16-33-8-25
	4	8 (3.6)	P14-43-8-25	P14-43-8-25	P16-43-8-25	P16-43-8-25	P16-43-8-25	P16-43-8-25	P18-43-8-25
	6	12 (5.4)	P16-63-8-25	P16-63-8-25	P18-63-8-25	P18-63-8-25	P21-63-8-25	P21-63-8-25	P21-63-8-25
	8	16 (7.2)	P16-83-9-25	P18-83-9-25	P21-83-9-25	P21-83-9-50	P24-83-9-50	P24-83-9-50	P24-83-9-50
	10	20 (9.0)	P21-103-11-25	P21-103-11-50	P24-103-11-50	P28-103-11-50	P28-103-11-50	P28-103-11-75	P28-103-11-75
	12	24 (10.8)	P24-123-12-50	P24-123-12-50	P28-123-12-50	P28-123-12-75	P28-123-12-75	P28-123-12-75	P28-123-12-75
	14	28 (12.6)	P24-143-13-50	P28-143-13-50	P28-143-13-75	P28-143-13-75	P28-143-13-150	P28-143-13-150	P28-143-13-150
	16	32 (14.4)	P24-163-12-50	P24-163-12-50	P28-163-12-75	P28-163-12-75	P28-163-12-75	P28-163-12-75	P28-163-12-150
	20	40 (18.0)	P24-203-13-75	P28-203-13-75	P28-203-13-75	P28-203-13-150	P28-203-13-150	P28-203-13-150	P28-203-13-150

## Gleason Pendant Station Reels...LOADED WITH FEATURES

**EASILY REMOVABLE SLIP-RING COVER...**Removes quickly for inspection or service. Held securely by three toggle clamps. "O" ring provides weatherproof, dust-tight, NEMA 4 (IP-54) seal. Hazardous location housings (Class I & II) are also available.



**FAST, EASY BRUSH REPLACEMENT...**Unique brush tension fingers permit quick removal while insuring proper tension.

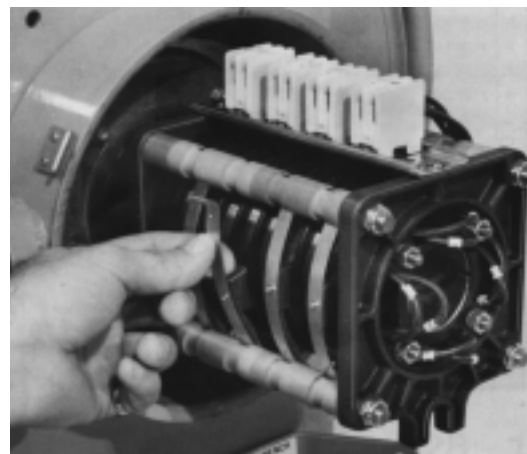

Gleason's simplified design eliminates the corroding and binding tendencies of conventional box-shaped brush holders.

selected to ensure optimum capacity.

	CABLE LENGTH—FEET					Max Pndnt. Wt lbs (kg)	No. Cond.	WIRE SIZE
	80	90	100	110	120			
	P14-23-8-25	P14-23-8-25	P14-23-8-25	P14-23-8-25	P14-23-8-25	4 (1.8)	2	No. 16
	P14-33-8-25	P14-33-8-25	P14-33-8-25	P14-33-8-25	P16-33-8-25	6 (2.7)	3	
	P14-43-8-25	P14-43-8-25	P14-43-8-25	P14-43-8-25	P16-43-8-25	8 (3.6)	4	
	P16-63-8-25	P16-63-8-25	P16-63-8-25	P16-63-8-25	P18-63-8-25	12 (5.4)	6	
	P18-83-8-25	P21-83-8-25	P21-83-8-25	P21-83-8-25	P21-83-8-25	16 (7.2)	8	
	P21-103-8-25	P21-103-8-25	P21-103-8-25	P24-103-8-25	P24-103-8-50	20 (9.0)	10	
	P21-123-8-25	P24-123-8-50	P24-123-8-50	P24-123-8-50	P24-123-8-50	24 (10.8)	12	
	P24-143-9-50	P24-143-9-50	P28-143-9-50	P28-143-9-50	P28-143-9-50	28 (12.6)	14	
	P21-163-8-50	P21-163-8-50	P21-163-8-50	P24-163-8-50	P24-163-8-50	32 (14.4)	16	
	P21-203-8-50	P24-203-8-50	P24-203-8-50	P28-203-8-50	P28-203-8-50	40 (18.0)	20	
	P24-243-9-50	P24-243-9-75	P28-243-9-75	P28-243-9-75	P28-243-9-75	48 (21.6)	24	
	P28-303-11-75	P28-303-11-150	P28-303-11-150			60 (27.0)	30	
	P28-363-11-150	P28-363-11-150	P28-363-11-150			72 (32.4)	36	
	P16-23-8-25	P16-23-8-25	P16-23-8-25	P16-23-8-25	P16-23-8-25	4 (1.8)	2	No. 14
	P16-33-8-25	P16-33-8-25	P16-33-8-25	P16-33-8-25	P16-33-8-25	6 (2.7)	3	
	P16-43-8-25	P16-43-8-25	P16-43-8-25	P16-43-8-25	P18-43-8-25	8 (3.6)	4	
	P18-63-8-25	P18-63-8-25	P21-63-8-25	P21-63-8-25	P24-63-8-25	12 (5.4)	6	
	P21-83-8-25	P21-83-8-25	P21-83-8-50	P24-83-8-50	P24-83-8-50	16 (7.2)	8	
	P24-103-9-50	P24-103-9-50	P28-103-9-50	P28-103-9-50	P28-103-9-50	20 (9.0)	10	
	P24-123-10-50	P28-123-10-50	P28-123-10-50	P28-123-10-75	P28-123-10-75	24 (10.8)	12	
	P28-143-11-75	P28-143-11-75	P28-143-11-75	P28-143-11-75		28 (12.6)	14	
	P28-163-10-50	P28-163-10-75	P28-163-10-75	P28-163-10-75	P28-163-10-75	32 (14.4)	16	
	P28-203-11-75	P28-203-11-75	P28-203-11-150			40 (18.0)	20	
						48 (21.6)	24	
						60 (27.0)	30	
	P16-23-8-25	P16-23-8-25	P16-23-8-25	P16-23-8-25	P18-23-8-25	4 (1.8)	2	No. 12
	P16-33-8-25	P16-33-8-25	P16-33-8-25	P16-33-8-25	P18-33-8-25	6 (2.7)	3	
	P18-43-8-25	P18-43-8-25	P18-43-8-25	P21-43-8-25	P21-43-8-25	8 (3.6)	4	
	P21-63-8-25	P21-63-8-25	P21-63-8-25	P24-63-8-25	P24-63-8-50	12 (5.4)	6	
	P21-83-8-25	P24-83-8-50	P24-83-8-50	P28-83-8-50	P28-83-8-50	16 (7.2)	8	
	P24-103-10-50	P28-103-10-50	P28-103-10-50	P28-103-10-75	P28-103-10-75	20 (9.0)	10	
	P28-123-11-75	P28-123-11-75	P28-123-11-75	P28-123-11-75		24 (10.8)	12	
						28 (12.6)	14	
	P28-163-10-75	P28-163-10-75	P28-163-10-75	P28-163-10-75	P28-163-10-150	32 (14.4)	16	
	P28-203-12-150					40 (18.0)	20	
						48 (21.6)	24	
	P18-23-8-25	P18-23-8-25	P18-23-8-25	P18-23-8-25	P18-23-8-25	4 (1.8)	2	No. 10
	P18-33-8-25	P18-33-8-25	P18-33-8-25	P21-33-8-25	P21-33-8-25	6 (2.7)	3	
	P18-43-8-25	P21-43-8-25	P21-43-8-25	P21-43-8-25	P21-43-8-25	8 (3.6)	4	
	P21-63-8-25	P24-63-8-25	P24-63-8-25	P24-63-8-50	P24-63-8-50	12 (5.4)	6	
	P28-83-9-50	P28-83-9-50	P28-83-9-50	P28-83-9-50	P28-83-9-50	16 (7.2)	8	
	P28-103-11-75	P28-103-11-75	P28-103-11-75	P28-103-11-75		20 (9.0)	10	
						24 (10.8)	12	
						28 (12.6)	14	
	P28-163-12-150					32 (14.4)	16	
						40 (18.0)	20	

**SIMPLE, ONE-PIECE SLIP-RING REMOVAL...**Entire slip-ring assembly can be replaced as a unit if necessary. No need to handle small parts. To remove, merely disconnect wiring and loosen two set screws on shaft locking collar.

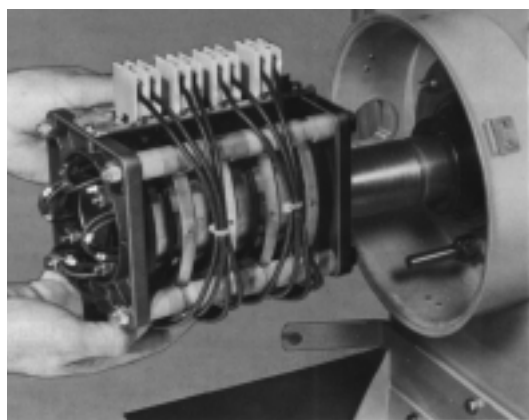

### Model Number Structure

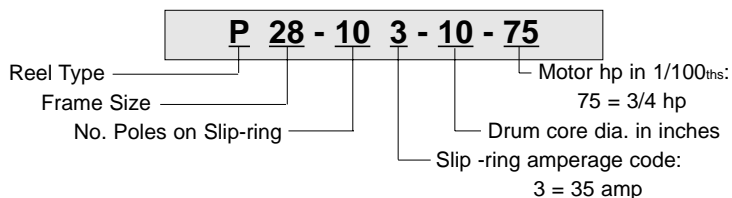

### Motor Specifications Common to All Models

**Starter Size (Furnished by customer):  
NEMA size 0 AC Magnetic Starter**

**Motor Current: 3 Phase, 230/460 Volt, 60 Cycle**

# PENDANT STATION REEL DIMENSIONS

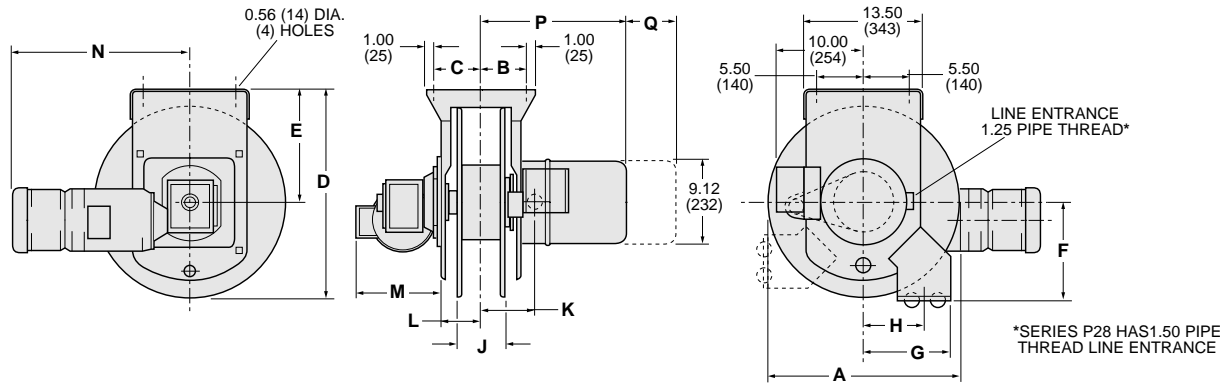

Reel Series	A	B	C	D	E	F	G	H	J	K	L
P14	14.00 (356)	4.75 (121)	4.75 (121)	16.50 (419)	9.00 (229)	7.75 (197)	9.50 (241)	6.50 (165)	4.25 (108)	5.25 (133)	4.12 (105)
P16	16.00 (406)	5.25 (133)	5.25 (133)	18.50 (470)	10.00 (254)	11.25 (286)	9.50 (241)	6.50 (165)	5.25 (133)	5.75 (146)	4.62 (118)
P18	18.00 (457)	5.25 (133)	5.25 (133)	20.00 (508)	11.00 (279)	11.25 (286)	9.50 (241)	6.50 (165)	5.25 (133)	5.75 (146)	4.62 (118)
P21	21.00 (533)	5.25 (133)	5.25 (133)	23.00 (584)	12.50 (318)	11.25 (286)	9.50 (241)	6.50 (165)	5.25 (133)	5.75 (146)	4.62 (118)
P24	24.00 (610)	5.25 (133)	8.75 (222)	26.00 (660)	14.00 (356)	12.75 (324)	10.12 (257)	7.12 (181)	5.25 (133)	5.75 (146)	4.62 (118)
P28	28.00 (711)	6.25 (159)	9.75 (248)	30.00 (762)	16.00 (406)	15.50 (394)	11.25 (286)	8.25 (210)	7.25 (184)	6.75 (172)	5.62 (143)

## MOTOR DIMENSIONS

Reel Series	Ref. Letter	Motor HP (Last digits in model number—P18-23-8-25)							
		0.25 HP	Net Weight*	0.50 HP	Net Weight*	0.75 HP	Net Weight*	1.50 HP	Net Weight*
P14	M	9.25 (235)	129 lbs.(58kg)						
	N	17.50 (445)							
P16	M	9.25 (235)	134 lbs.(60kg)	9.38 (238)	150 lbs.(68kg)				
	N	17.50 (445)		17.00 (432)					
P18	M	9.25 (235)	144 lbs.(65kg)	9.38 (238)	160 lbs.(72kg)	9.81 (249)	194 lbs.(87kg)		
	N	17.50 (445)		17.00 (432)		20.00 (508)			
P21	M	9.25 (235)	154 lbs.(69kg)	9.38 (238)	170 lbs.(77kg)	9.81 (249)	204 lbs.(92kg)		
	N	17.50 (445)		17.00 (432)		20.00 (508)			
P24	M	9.25 (235)	179 lbs.(81kg)	9.38 (238)	195 lbs.(88kg)	9.81 (249)	229 lbs.(103kg)		
	N	17.50 (445)		17.00 (432)		20.00 (508)			
P28	M			9.38 (238)	210 lbs.(95kg)	9.81 (249)	244 lbs.(110kg)	9.75 (248)	256 lbs.(115kg)
	N			17.00 (432)		20.00 (508)		24.00 (610)	

\* Net weight includes reel and motor.

## SLIP RING HOUSING DIMENSIONS

Reel Series	Ref. Letter	Slip Ring Size (Second digits in model number—P18-23-8-25)					
		23, 33, 43	63, 83	103, 123	143, 163	203, 243	303, 363
P14	P	14.50 (368)	17.00 (432)				
	Q	8.50 (216)	11.00 (279)				
P16	P	15.00 (381)	17.50 (445)	20.00 (508)	22.50 (572)	27.50 (699)	
	Q	8.50 (216)	11.00 (279)	13.50 (343)	16.00 (406)	21.00 (533)	
P18	P	15.00 (381)	17.50 (445)	20.00 (508)	22.50 (572)	27.50 (699)	35.50 (902)
	Q	8.50 (216)	11.00 (279)	13.50 (343)	16.00 (406)	21.00 (533)	29.00 (737)
P21	P	15.00 (381)	17.50 (445)	20.00 (508)	22.50 (572)	27.50 (699)	35.50 (902)
	Q	8.50 (216)	11.00 (279)	13.50 (343)	16.00 (406)	21.00 (533)	29.00 (737)
P24	P	15.00 (381)	17.50 (445)	20.00 (508)	22.50 (572)	27.50 (699)	35.50 (902)
	Q	8.50 (216)	11.00 (279)	13.50 (343)	16.00 (406)	21.00 (533)	29.00 (737)
P28	P	16.00 (406)	18.50 (470)	21.00 (533)	23.50 (597)	28.50 (724)	36.50 (927)
	Q	8.50 (216)	11.00 (279)	13.50 (343)	16.00 (406)	21.00 (533)	29.00 (737)



### Gleason Reel Corp.

P.O. Box 26 • 600 S. Clark St.  
 Mayville, Wisconsin 53050-0026  
 Phone 920-387-4120 • FAX 920-387-4189

In your area contact: